

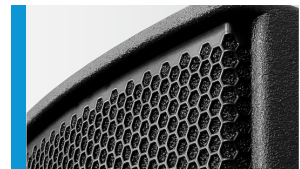

Leistungsstarkes und universelles Mittelhochtonsystem in dipolarer 2 x 8" Nd / 1" Anordnung. Gute Eignung als kräftiges Topteil in Kombination mit Subwoofern und als „Stand Alone“ System zur Sprachübertragung auf kleinen und mittleren Distanzen. Vier M10 Aufnahme­punkte (optional fünf bei Austausch gegen die werkseitig montierte HS-Flanschbuchse) ermöglichen in Kombination mit dem Zubehör eine einfache Installation in Horizontal- und Vertikal­ausrichtung.

PRODUCT SPECIFICATIONS

Speaker Components	2 x 8" Nd / 1"
Description	HiMid Sound System
Power AES / Peak	500 W / 1500 W
Impedance nominal	4 Ω (16 Ω optional)
SPL 1 W / Peak @ 1 m	100 dB / 132 dB
Usable Range	80 Hz - 20 kHz (-6 dB)
Tuning Frequency excursion minimum	90 Hz
X - Overpoint acoustical	1,4 kHz
Coverage horizontal / vertical	90° x 60° rotatable
Connectors	2 x Speakon NL4MP in/out Coding: 1 +/- HiMid, 2 +/- loop through
Handles	1 x
Rigging / Fittings	4 x M10, 2 x M6 35 mm pole mount
Weight	12,5 kg
Size height x width x depth	59,0 x 25,0 x 25,0 cm
Order No.	00240/ II



DIMENSIONS

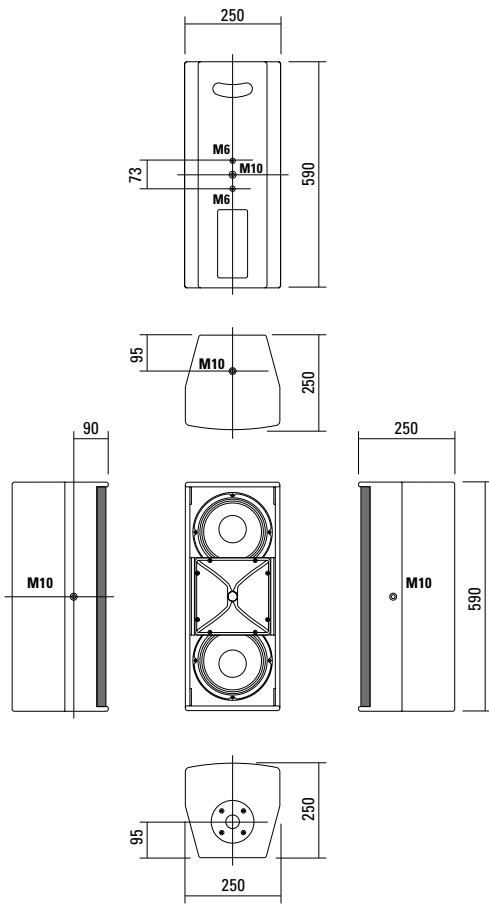

Controller Setups:

<https://www.seeburg.com/de/downloads>

Sensitivity 1 W @ 1 m + Impedance

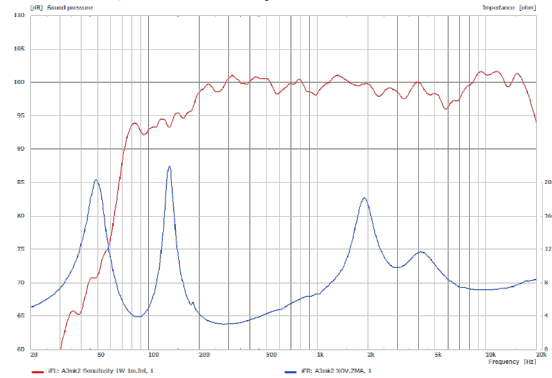

COVERAGE PATTERNS

2D Directivity Plot - horizontal

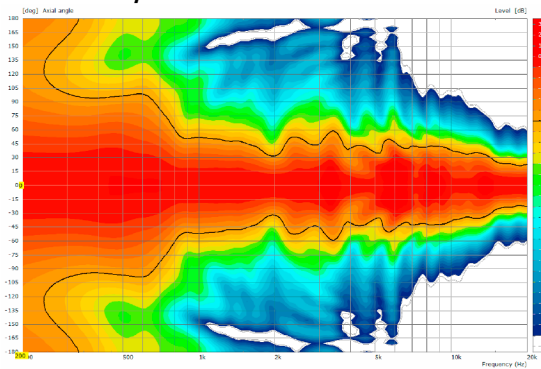

2D Directivity Plot - vertical

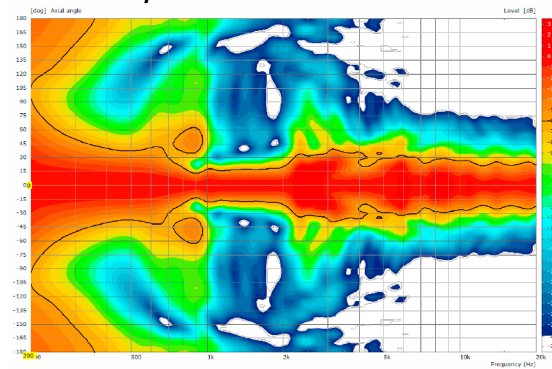

Flying Bracket



for A 3
horizontal alignment,
incl. (2 x M10 x 20 socket head
screws, 2 x rubber washers,
1 x plate)

Order No. **01215/H/set/w** (RAL 9010)
Order No. **01215/H/set**

Flying Bracket



for A 3
incl. (black version: 2 x M10 x 20
handle screws, 2 x rubber washers
white version: 2 x M10 x 20 socket
head screws, 2 x rubber washers)

Order No. **01215/set/w** (RAL 9010)
Order No. **01215/set**

Handle Screw

for flying brackets, adjustable

Order No. **08375/20** (M10 x 20)



Rubber Washer

for flying brackets,
5 mm x 40 mm Ø

Order No. **01206**



Plate

for A 2 / A 3 flying brackets,
horizontal alignment,
replacement for pole mount flange,
110 mm Ø flange with M10 nut

Order No. **08119/M10/w** (RAL 9010)
Order No. **08119/M10**



Knurled Head Nut

reduction screw for fastening
M10 Pole Mount Adapter (08126)

Order No. **73755**



Pole Mount Adapter

35 mm Ø → M10 x 16 mm,
M8 x 20 star knob screw

Order No. **08126**



Flange



with ball and socket joint,
with additional locking screw,
M10 x 15, max. load 15 kg

Order No. **08125**

Quick Trigger Clamp

max. load 100 kg

Order No. **01223/100 kg**



Quick Trigger Clamp - small

M10, max. load 20 kg

Order No. **01223/20 kg**



Truss Clamp

incl. M10 Adapter,
max. load 15 kg

Order No. **01221**



Steel Safety

6 mm x 600 mm, black,
max. load 22 kg (BGI 810-3),
quick connector undetachably

Order No. **01376/6**



Ring Screw

M10– DIN 580

Order No. **73700** (zincd)

Order No. **73700/sw** (black zincd)



TV Spigot

10 mm internal thread,
28 mm Ø

Order No. **08128**



ACCESSORIES A 3

Wall Mount



bar: 269 mm, max. load 40 kg,
incl. (M10 x 70 mm socket head screw,
M10 hex lock nut and flat washer)

Order No. **08130/F/269/w** (RAL 9010)
Order No. **08130/F/269**

Wall Mount



2 x M6 fixing holes (d=73 mm),
1 x M10 fixing hole (center),
max. load 25 kg

Order No. **03034/w** (RAL 9010)
Order No. **03034**

Wall Mount



ball and socket joint flange (08125)
+ 08125/plate

Order No. **08125/set**

Spacer



for Wall Mount (03034)
polyurea coated

Order No. **03034/spc**

Honeycomb Grilles

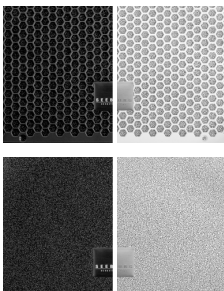

for A 3 front replacement.

Foam behind grille
Order No. **97006/hex/compl**
Order No. **97006/hex/compl/w**
(RAL 9010)

Foam in front of grille
Order No. **97006/compl.**
Order No. **97006/compl/w**
(RAL 9010)

Speaker Stand



K&M, incl. wind up,
height 138,5 to 218 cm,
max. load 50 kg,

Order No. **03011**

K&M, height 137,5 to 218,5 cm,
max. load 50 kg,

Order No. **03010**

Cover



for A 3, padded

Order No. **01258**

Rain Cover



for A 3

Order No. **01258/outdoor**

Flight Case Trunk

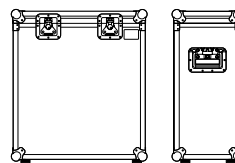

for 2 pcs. A 3 and accessories,
standard, 7 mm birch multiplex,
PVC coated, hinged lid, 2 x recessed
sprung handles, 2 x butterfly catches,
4 x 100 mm blue wheels, 2 pcs. with
brake, rubber feet, partition walls,
interior lined with felt.

Order No. **16066**

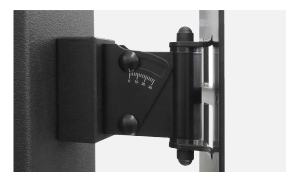

Spacer -> Wall Mount